

For indoor use only SPECIFICATION

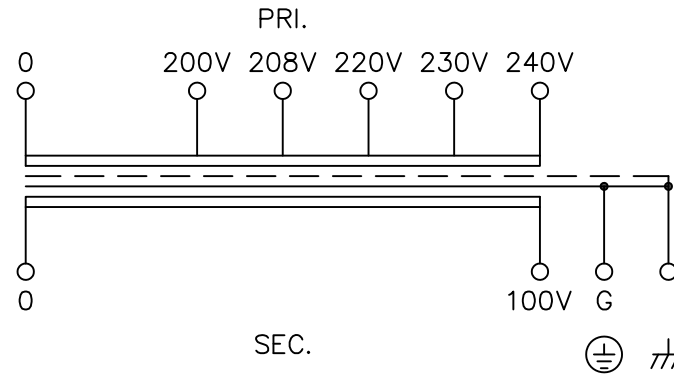

MODEL	FUL21-500		
STANDARD	EN61558-2-4	UL506	
PHASE	(Φ)	1	
FREQUENCY	(Hz)	50/60	
CAPACITY	(VA)	500	
PRI. VOLTAGE	(V)	200,208,220,230,240	
SEC. VOLTAGE	(V)	100	
SEC. CURRENT	(A)	5	
PERCENT IMPEDANCE	(%)	6.2/6.3	
DIELECTRIC STRENGTH(V/min)	P-S,G	4200	2500
	S-G	2800	2500
INSULATION RESISTANCE	more than 100 MΩ at DC 500V Megger		
RATING	CONTINUOUS		
CLASS	F (SYSTEM 14)		
MASS	(kg)	7.2	
MAX.AMBIENT TEMP.	(℃)	40	
MAX.TEMP.RISE	(K)	100	100
PRI. CIRCUIT BREAKER	5A (EN60947-2)		
SEC. CIRCUIT BREAKER	5A (EN60947-2)		
PROTECTION DEGREE	IP00		
IEC MARK			
TUV & CE MARK			
UL MARK			
UL FILE No.	E252316		

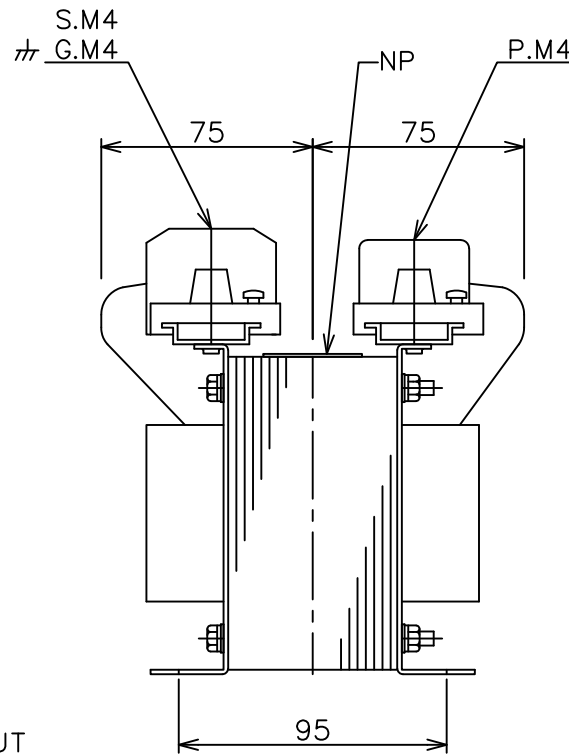
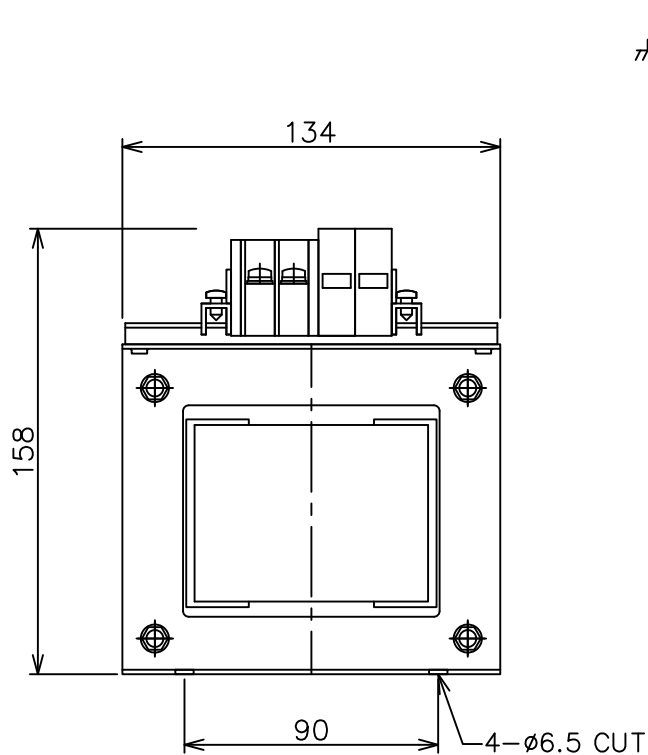

1	Geographical plot of a rated nameplate	2008/03/13
MARK	DESCRIPTIONS	DATE

REVISIONS			
NAME	DATE	SCALE	
DRAWN BY	S.Mine	2006/12/20	TITLE TRANSFORMER
CHECKED BY	T.Ariyama	2006/12/20	
FUKUDA ELECTRIC WORKS CO.,LTD.		DRAWING No. T-42767-500-M	